

SERVICE PARTS AND KITS

A	240002DAV	Collar
B	240023DAV	Vent Cap Service Kit (vent cap and o-ring)
C	243013SDAV	Cover, Collar, Spring, Vent Cap and Vent Cap O-ring (Collar o-ring not included)
D	243017DAV	Cover with Red Stripe, Collar, Spring, Vent Cap and Vent Cap O-ring (Collar o-ring not included)

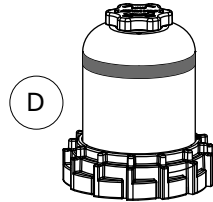

E	232009DAV	O-ring Service Kit
F	380056DAV	Spring
G	245013DAV	Check Valve Service Kit (Includes Ball, Spring, and Retainer)



H	245010DAV	Check Valve Assembly (Includes Body (1/2") and Check Valve Service Kit)
---	-----------	-------------------------------------------------------------------------

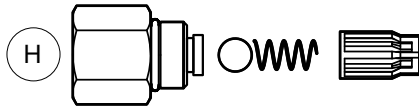

	245014DAV	Check Valve Assembly (Includes Body (3/8") and Check Valve Service Kit)
--	-----------	-------------------------------------------------------------------------





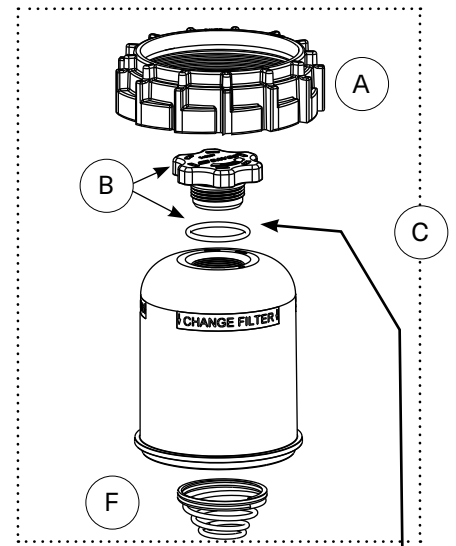
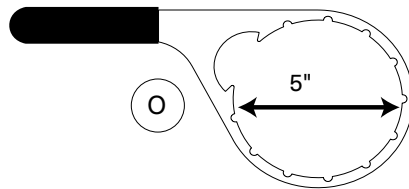

I	245011DAV	Adapter 7/8"-14 to M22
J	102821SDAV	Plug 7/8"-14
K	485022DAV	Quick Connect Drain Valve
L	485021DAV	Drain Valve Seal Service Kit
M	102712DAV	Drain Valve Dust Cap
N	390456DAV	WIF Port Plug 1/2"-20
O	232007DAV	Collar Wrench

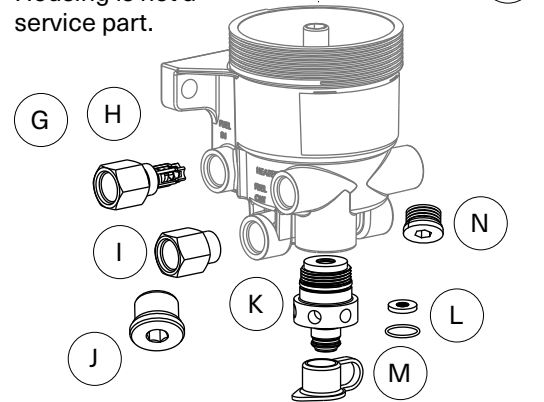

Housing is not a service part.

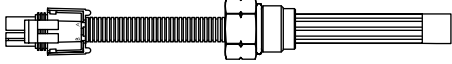
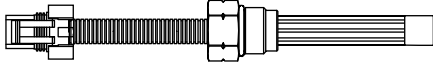
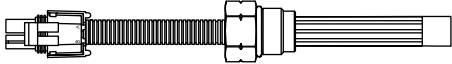
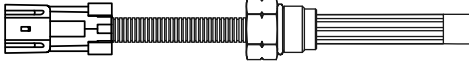
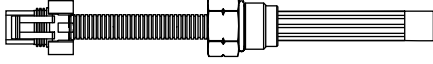

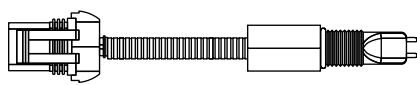
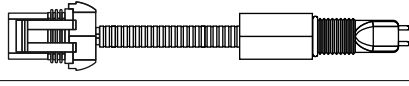
FILTERS ARE AVAILABLE THROUGH OEM DISTRIBUTORS	
DDC	A0000904851
Fleetguard	FS20081

PRE-HEATER PARTS AND WATER-IN-FUEL (WIF) SENSOR PARTS		
103525DAV	12VDC 195W PTC Pre-heater, Weather Pack Connector, 7/8"-14 UNF Threads, Harness Length 7.50"	
103526DAV	12VDC 195W PTC Pre-heater, Metri-Pack Connector, 7/8"-14 UNF Threads, Harness Length 7.50"	
103540DAV	24VDC 195W PTC Pre-heater, Weather Pack Connector, 7/8"-14 UNF Threads, Harness Length 7.50"	
103552DAV	12VDC 195W PTC Pre-heater, Metri-Pack Connector, 7/8"-14 UNF Threads, Harness Length 7.50"	
103595DAV	12VDC 155W PTC Pre-heater, Metri-Pack Connector, 7/8"-14 UNF Threads, Harness Length 7.50" (Freightliner Only)	
102512DAV	Two Pin WIF, Deutsch Connector (gray), 1/2"-20 UNF Threads, Harness Length 3.36"	
102697DAV	Two Pin WIF, Metri-Pack Connector, 1/2"-20 UNF Threads, Harness Length 17.5"	
102770DAV	Two Pin WIF, Metri-Pack Connector, 1/2"-20 UNF Threads, Harness Length 6.50" (Freightliner)	
103111DAV	Two Pin WIF, Tyco/AMP Connector, 1/2"-20 UNF Threads, Harness Length 3.25" (Paccar)	

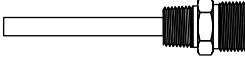
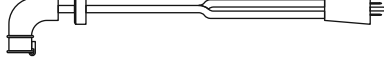
OVERNIGHT HEATER PARTS		
120VAC 75W Overnight heater	102145DAV	
120VAC Straight Cord	101868DAV	

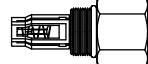
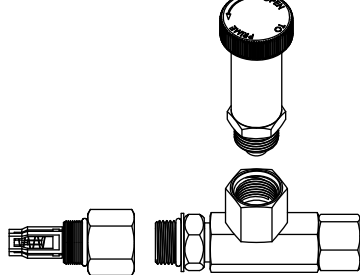
PRIMER PUMP PARTS		
Check Valve for Primer pump, 7/8"-14"	103030DAV	
Kit, Primer pump 1/2"-14", Includes Plunger, Tee Fitting, Check Valve and Instructions	103036DAV	
Kit, Primer pump 3/8"-18", Includes Plunger, Tee Fitting, Check Valve and Instructions	103292DAV	