



A Clariance Technologies Company

TABLE OF CONTENTS

Applications and Features 1

Shop Pro® ST Components 2

△ Important Safety Precautions 3

Set-up and Maintenance 4

Hoses and Adapters 5

Hose Connections Priming 6

Priming the Fuel Module with Compuchek Fitting 7

Hose Connections for Priming at 50 PSI 8

Priming with Regulator settings of 50 PSI 10

Fuel Tank Sweeping with Filtration 11

Fuel Transfer with Filtration 12

Service Parts 13

Service Parts - Adapters 14

Warranty Policy 15

Parts Return Policy 16

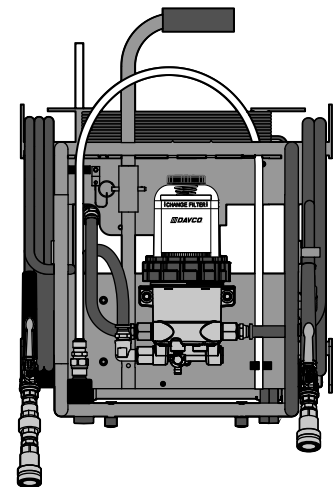
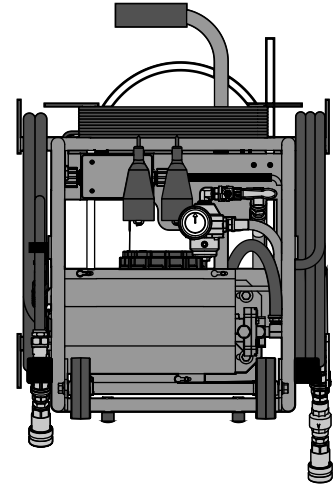

FOR UPDATED INFORMATION VISIT WWW.DAVCO.COM

SHOP PRO® ST
WITH 50/80 PSI REGULATOR
TECHNICAL MANUAL

APPLICATIONS AND FEATURES

⚠ Product Warning: The Shop Pro is only approved for use with diesel fuel. It is not approved for use with gasoline or any other flammable liquids.

Applications

- **Priming after Filter Service**
 - Eliminates the use of hand priming pumps after performing maintenance
 - Uses on-board fuel to prime engines and filters, avoids the hassle of keeping reserve fuel on hand
 - Eliminates cross contamination of fuel
- **Fuel Transfer**
 - Filters and transfers fuel in one operation
 - Transfers fuel when repairing tanks or crossover lines
 - Transfers fuel for trucks being sold or taken out of service
- **Tank Cleaning**
 - Removes contaminated fuel, sediment and water from fuel tanks of diesel powered equipment or from diesel storage tanks
 - Cleans fuel tanks during service — can be a value added service or a new revenue stream
 - Eliminates downtime due to fuel contamination

Specifications

- Height: 24" handle down, 38" handle up
- Width: 21"
- Depth: 24"
- Weight: 35 lbs
- Electric Motor: 12VDC, 3000 RPM, UL® Listed
- Flow Rate: 12VDC: 91 GPH

Shop Pro Filtration

- All-in-one fuel filter and water separator for diesel fuel
- Superior fuel/water separation
- Easy to access drain
- Lightweight aluminum construction

Features

- **Cart**
 - Heavy-duty steel construction
 - Portable and self-contained
- **Electrical**
 - UL® Listed, rear-facing receptacle
 - Waterproof ON/OFF switch
 - 12VDC connection
- **Pump and Motor**
 - Electric motor/pump combination rated for continuous operation
 - UL® Listed and CSA approved
- **Adapters and hoses**
 - No-drip fittings
 - Color-coded for function
- **Regulator**
 - 50 psi (handle up, range of 45 psi to 50 psi) for use on MaxxForce Engines
 - 80 psi (handle down, range of 75 psi to 80 psi) for use on other applications

SHOP PRO[®] ST COMPONENTS

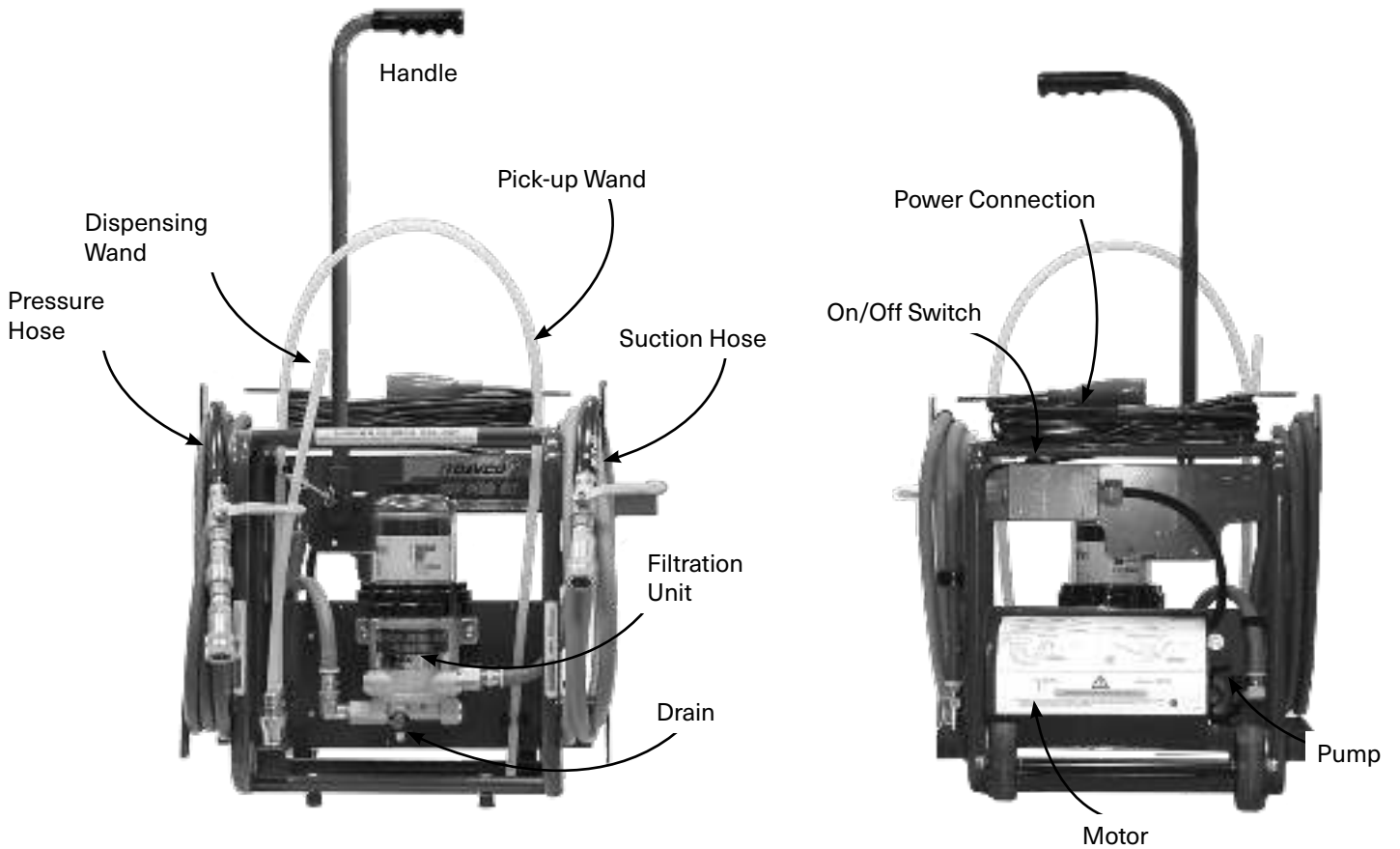

⚠ IMPORTANT SAFETY PRECAUTIONS

General Safety Precautions

- The Shop Pro is only approved for use with diesel fuel. It is not approved for use with gasoline or any other flammable liquids.
- Read all instructions before use to avoid injury.
- To avoid serious injury or death, follow the safety information in this document.
- Keep this manual. If you need to replace the manual, call customer service at 800-328-2611 or visit www.davco.com for a replacement.
- Read all product safety labels.
- Refer to appropriate regulations for environmental and workplace safety rules.

⚠ **WARNING: To prevent personal injury**

- **Recommended Personal Protection Equipment:**

- Eye Protection
- Chemical resistant gloves

- **Avoid Fuel Spillage:** When disconnecting attachments equipped with Quick connect fittings, wrap a shop rag around the fitting to catch any residual fuel. Allow fuel to drain back into hoses before closing ball valves to avoid spillage when returning hoses to the Cart.
- Do not leave the Shop Pro running unattended. Follow engine manufacturer guidelines for proper priming procedures. Always disconnect the power supply when the Shop Pro is not in use.
- **Scalding hazard:** When diesel fuel is circulated through an operating engine, it can become very hot. Do not allow fuel to come in contact with eyes or unprotected skin. Allow the engine and fuel to cool to ambient temperature before replacing the fuel filter or performing service operations which could result in spillage of fuel from the fuel system.

- **Fire Prevention:** Heated fuel can form combustible vapor mixtures in the area around the fuel source. To eliminate the potential for fire, keep open flames, sparks or other potential ignition sources away from the work area. Do not smoke during filter replacement or service operations.
- **Inhalation Precaution:** Always perform engine or vehicle fuel system maintenance in a well ventilated area that is kept free of bystanders.
- The ignition key must be in the **off** position, unless otherwise directed. To avoid unintentional engine startup, use a lockout key and/or signage to alert personnel that work is being performed.

Government Regulations

- Engine fluids (oil, fuel, and coolant) may be a hazard to human health and the environment. Handle all fluids and other contaminated materials (such as filters and rags) in accordance with applicable regulations. Recycle or dispose of engine fluids, filters, and other contaminated materials according to applicable regulations.

SET-UP AND MAINTENANCE

Set-up and First Use

1. Unpack the Shop Pro ST and remove cable ties from hoses.
2. Remove the vent cap from the filtration unit.

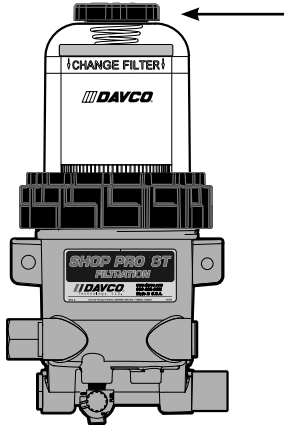

3. Pour diesel fuel into the clear cover until it reaches the black band on the filter element. (This fuel will be on the "dirty" side of the filter, meaning that the fuel will be filtered before flowing through the Shop Pro ST to the engine or tank.)
4. Reinstall the vent cap and tighten by hand until it clicks. The Shop Pro ST is now ready for use.
5. Connect the Shop Pro to a power source. Install the pick-up wand (green hose) and dispensing wand (red hose). Put the wands in a five gallon (minimum) fuel container or truck fuel tank. Turn the Shop Pro power on and circulate fuel until there are no bubbles in the sight tube. Turn off the Shop Pro. Close the ball valves on both hoses. Remove the wands from the hoses and return them to their storage area. Connect the hoses to the hose retainers. (Refer to photo on page 2.)

Filtration Unit Maintenance

Drain Water

Water that has been separated from fuel will collect in the bottom of the body of the filtration unit. Drain the water periodically. The frequency will depend on how often the Shop Pro is used and the quality of the fuel it has filtered.

1. Open the vent cap slightly to break the vacuum. Place the end of the drain hose in a suitable container and open the drain valve.
2. When only fuel is coming out of the hose, shut the valve. Hand tighten the vent cap until it clicks.

Filter Replacement

Replace the filter in the filtration unit when there is low flow/pressure or when the filter is visibly contaminated. The filter change will also include replacement of the seals on the vent cap and on the collar.

1. Remove the vent cap and open the drain valve to drain the fuel below the collar level. Close the drain valve.
2. Remove the collar (use the DAVCO wrench) then remove the clear cover. Remove the filter. Remove the seals from the cover and the vent cap. Dispose of the filter and the seals properly.
3. Using a clean shop rag, clean the cover, vent cap, collar and threads on the filtration unit body. Do not use any acetone based cleaners on the clear cover.
4. Install the new filter and the seals (included with the replacement filter).

Pro Tip: Write the date of the filter change with a permanent marker on the filter wrap.

Pro Tip: Install the cover and collar on the filtration unit housing. Apply downward pressure on the top of the cover and rotate the collar until contact. Use a DAVCO wrench to tighten three additional ribs.

5. Pour clean fuel into the filtration unit.
6. Reinstall the vent cap and tighten by hand until it clicks.

Replacement filter part number:



Fleetguard: FS19624

Service Parts





See 13 for service parts. Call DAVCO customer service at 800-328-2611 to order.

HOSES AND ADAPTERS

HOSES

Hose	Connection	Description	Photo
Red	Quick connect	Pressure Hose with check valve	
Green	Quick connect	Suction Hose	

ADAPTERS

Hose	Connection	Description	Photo
Blue	Compuchek	Compuchek fitting for priming Fuel Module	
Red	Voss	Priming MaxxForce Engines using regulator setting of 50 PSI	
Green	Voss	Priming MaxxForce Engines using regulator setting of 50 PSI	
60" White tube	Quick connect	Pick-up Wand: Put in fuel tank or container	
20" White tube	Quick connect	Dispensing Wand: Tank sweeping or fuel transfer	

HOSE CONNECTIONS PRIMING

Priming with Compucheck Adapter—Use 80 PSI Setting on Regulator

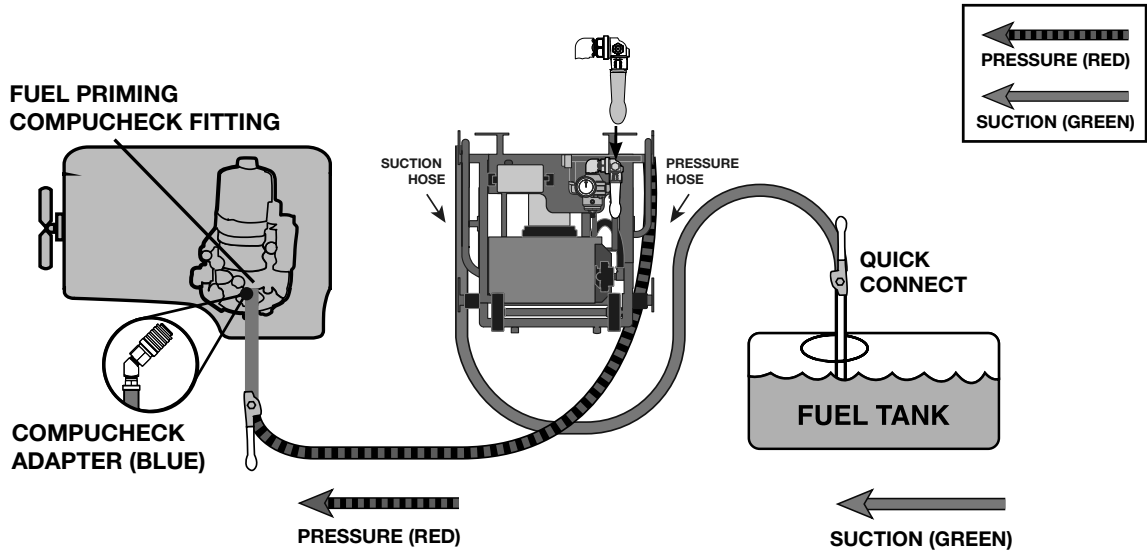

PRIMING THE FUEL MODULE WITH COMPUCHECK FITTING**Regulator Settings:**

Use the 80 PSI Regulator setting to prime the fuel module.

1. Connect the Shop Pro to a power source.
2. Attach the Pick-up (60") wand to the suction hose (green) and insert it into the fuel tank.
3. Open the ball valve.
4. Attach the Compucheck Adapter (blue hose) to the pressure hose (red) on the Shop Pro.

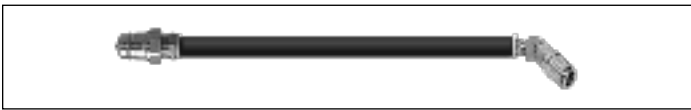

5. Connect the Compucheck fitting to the priming port on the fuel module.



6. Open the ball valve.



7. Turn the Shop Pro FXP ON. Prime the fuel system for four minutes.
8. While the Shop Pro is still turned ON, start the engine. Allow the engine to idle for one minute before revving the engine. Turn off the engine.
9. Turn the Shop Pro off. Close the Shop Pro pressure hose ball valve. Remove the Compucheck adapter from the fuel module.
10. Remove the pick-up wand from the fuel tank. Allow the fuel to drain back into the tank before closing the ball valve.
11. Return the adapters and hoses to the Shop Pro cart.
12. Restart the truck and check for leaks.

HOSE CONNECTIONS FOR PRIMING AT 50 PSI

Priming with Regulator Settings of 50 PSI

Use on engine applications that require 50 PSI for priming

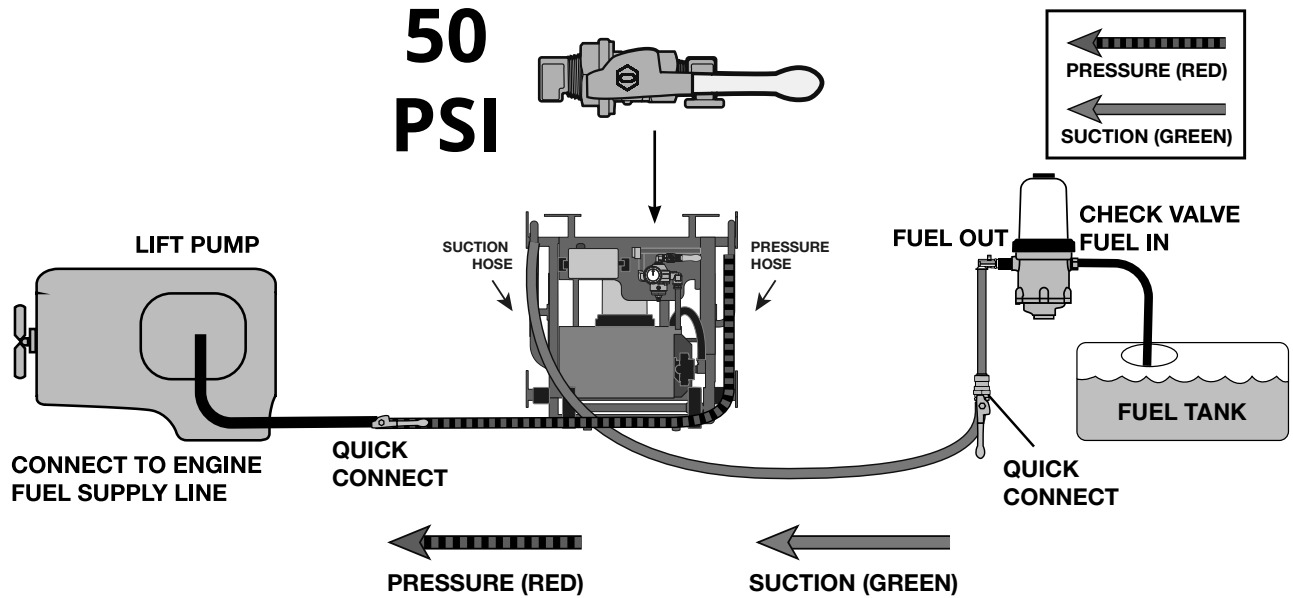
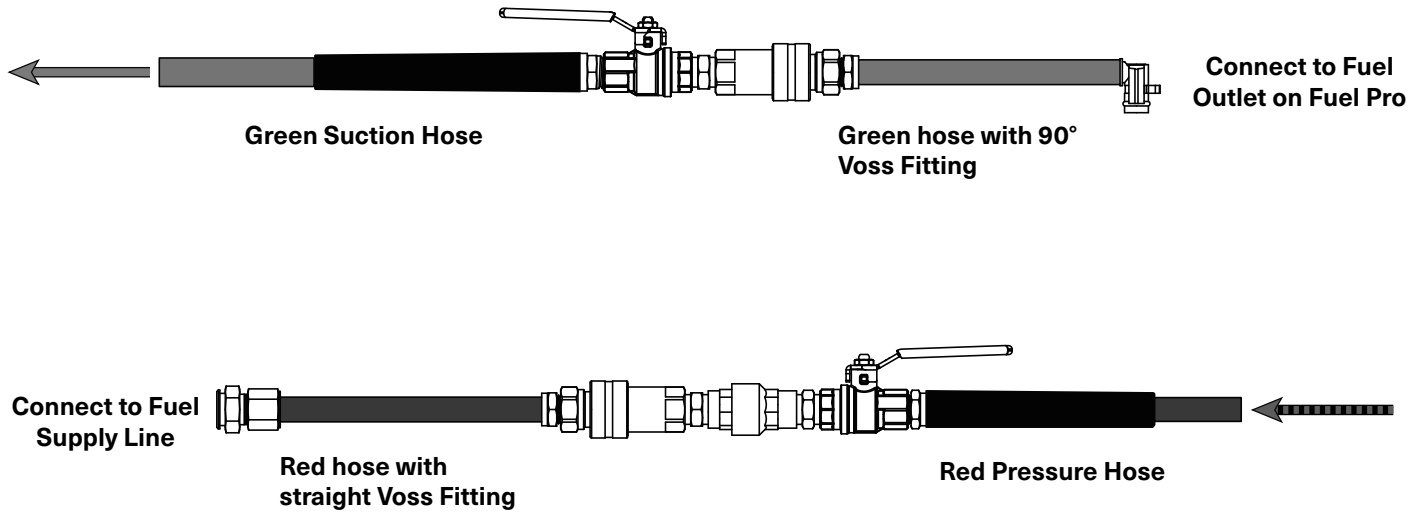

PRIMING WITH REGULATOR SETTINGS OF 50 PSI

⚠ CAUTION! To prevent damage to fuel system components, make sure pressure regulator handle is in 50 PSI position when servicing MaxxForce® 11, 13 and 15 engines.

**50
PSI**

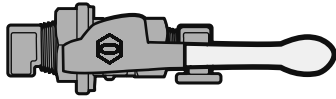

1. Connect the Shop Pro to a power source.
2. Attach the green Voss adapter to the suction hose (green).



3. Connect the red Voss adapter to the pressure hose (red).



4. Disconnect the fuel supply line from the FUEL OUT port.



5. Connect the green Voss adapter to the Fuel Pro inlet fitting. (Item 3).
6. Connect the engine fuel supply line (Item 1) to the red Voss adapter (Item 2).



⚠ CAUTION: USE CARE WHEN CONNECTING VOSS FITTINGS TO AVOID ACCIDENTAL BREAKAGE.

7. Open the ball valves (Items 1 and 2).

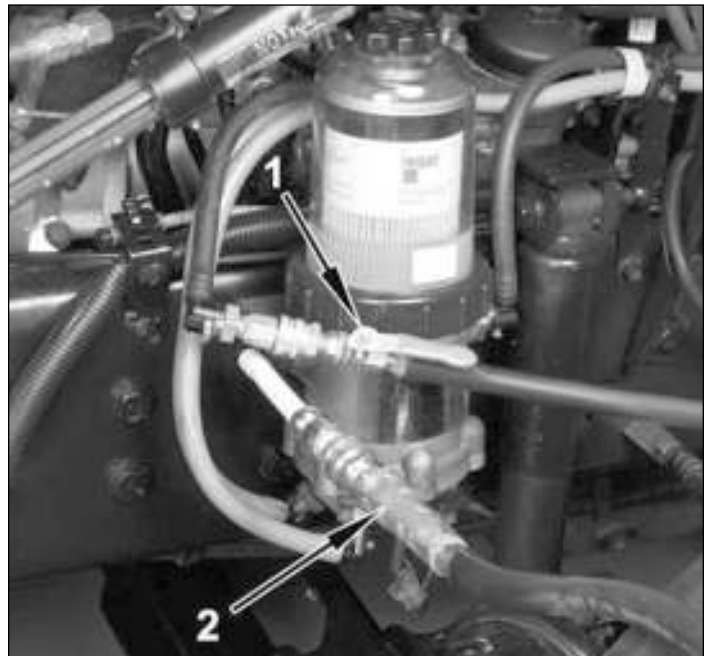

PRIMING WITH REGULATOR SETTINGS OF 50 PSI

8. Turn the Shop Pro ON. Let the Shop Pro run for a minimum of two minutes after no bubbles are visible in sight glass.
9. Start the engine and run the engine at 1200 rpm for a minimum of two minutes. Turn off engine.
10. Turn the Shop Pro OFF.
11. Close pressure and suction hose ball valves (Items 1 and 2).



12. Disconnect the adapters from the fuel line and Fuel Pro.
13. Reconnect the fuel supply line to Fuel Pro FUEL OUT port.
14. Return the adapters to the cart. Return the hoses to the cart. Connect the hoses to the hose retainers.
15. Restart the truck and check for leaks.

FUEL TANK SWEEPING WITH FILTRATION

Overview:

The suction hose (green) is connected to the pick-up wand (60" white wand). The pressure hose (red) is connected to the dispensing wand (20" white wand). The fuel is filtered as it is drawn from the tank and returned to the same tank (or auxiliary tank). By moving the wand along the sides and bottom of the tank, water and contaminants that have settled in the tank are removed. The sight tube aids in determining the length of time needed to clean the tank.

Use the regulator setting of 80 PSI.

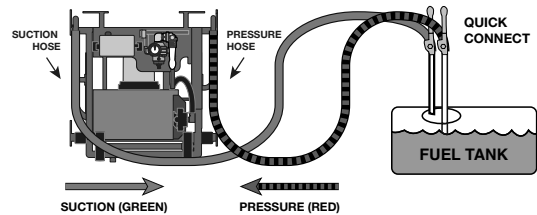

Pro Tip: Remove the anti-siphon fill cap from the fuel tank before sweeping.

Pro Tip: Elevate the end of the truck to allow water and contaminants to collect closest to the fuel fill point.

1. Connect the Shop Pro to a power source.



2. Attach the 60" pick-up wand to the suction hose (green) and insert it into the fuel tank.
3. Open the ball valve.
4. Attach the 20" dispensing wand to the pressure hose (red).
5. Insert the dispensing wand into the fuel tank and open the ball valve.
6. Turn the Shop Pro ON.
7. With the pick up wand, slowly sweep the bottom and sides of the fuel tank with a side-to-side motion. If the tank being cleaned has excessive water (visible in the clear cover) turn the Shop Pro off and drain the filtration unit.
8. When sweeping is complete, run for one additional minute to flush residual water from the Shop Pro to prevent gear corrosion. Turn the Shop Pro OFF.
9. Remove the wands from the fuel tank. Allow the fuel to drain back into the tank before closing the ball valves.
10. Return the wands to the cart.
11. Return the hoses to the hose retainers.

FUEL TRANSFER WITH FILTRATION

Overview:

The suction hose (green) is connected to the pick-up wand (60" white wand). The pressure hose (red) is connected to the dispensing wand (20" white wand). The fuel is filtered as it is drawn from the **Tank A** or storage container and transferred to **Tank B**. Water and contaminants that have settled in the tank are removed as the fuel is transferred between the tanks.

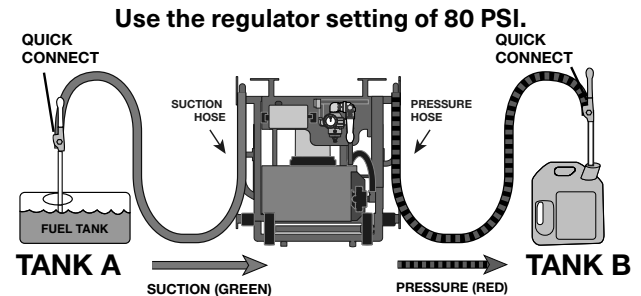

1. Connect the Shop Pro to a power source.

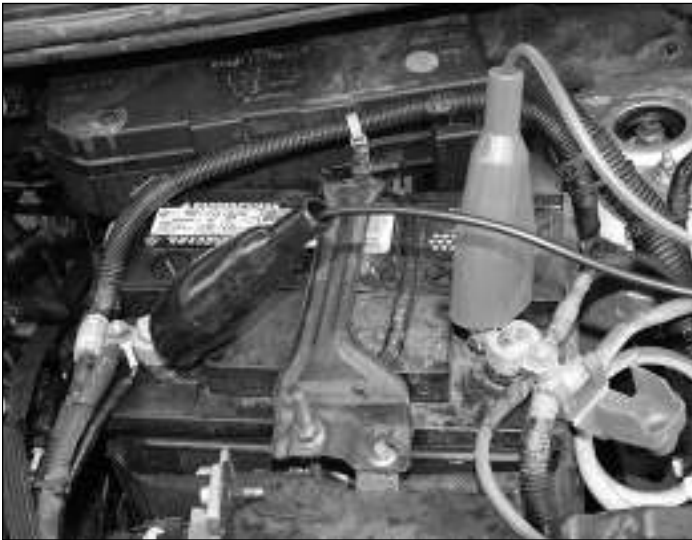

2. Attach the 60" pick-up wand to the suction hose (green) and insert it into the fuel tank.
3. Open the ball valve. Attach the 20" dispensing wand to the pressure hose (red). Insert the dispensing wand into the fuel tank or container that the fuel is to be transferred to.
4. Open the ball valve.
5. Turn the Shop Pro ON. If the tank the fuel is being transferred from has excessive water (visible in the clear cover) turn the Shop Pro off and drain the filtration unit.
6. When the fuel transfer is complete, run for one additional minute to flush residual water from the Shop Pro to potential pump corrosion. Turn the Shop Pro OFF.
7. Remove the wands from the fuel tank. Allow the fuel to drain back into the tank before closing the ball valves.
8. Return the wands to the cart.
9. Return the hoses to the hose retainers.

SERVICE PARTS

CART		
A	Plugs (10) 1.5" x 1.5" Sq	772019S
B	Clip w/ Screws (Sm)	772034S
C	Clip w/ Screws (Lg)	772033S
D	Motor Cover and (5) Screws	782126S-B
	Motor Bracket and Fasteners (Not Shown)	782088S-B
E	Handle Asm	772031S-B
	Pump Bracket, Washers & Screws (Not Shown)	782214S-B
F	Wheels, Axle and Bumpers	772029S

ELECTRICAL		
G	Coupler Asm	782098S
H	Electrical Box 12V with Switch	782106S
I	Electrical Switch 12V	782099S
	Motor (Not Shown)	782078S
J	Pump	782002S





FILTRATION		
L	Cover, Collar, Spring, Vent Cap and Vent Cap O-rings	243013SDAV
M	Filtration Unit w/Fasteners regulated Shop Pro ST	772030S
N	Regulator Asm	772025S
O	Wrench	232007DAV
P	Fleetguard Brand 7 micron	FS19624

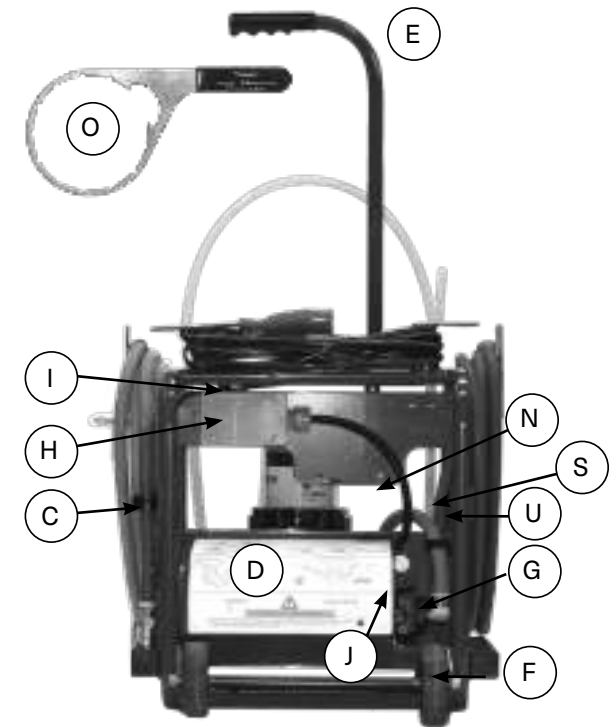
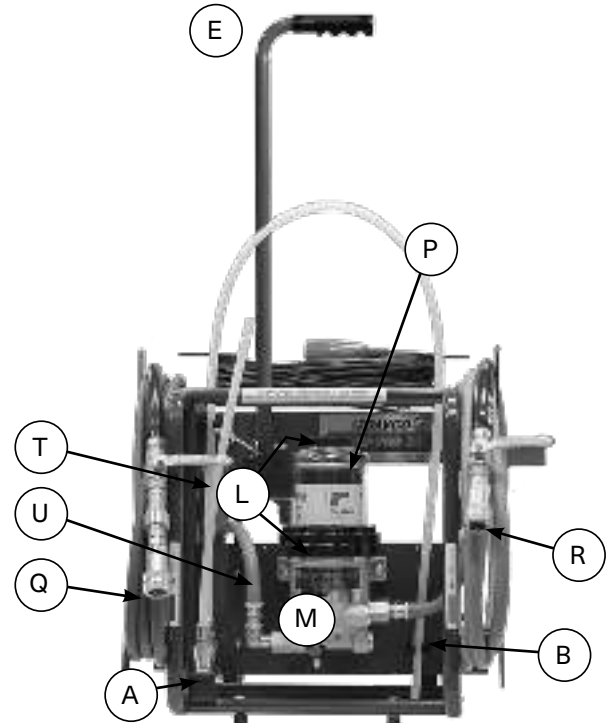







HOSES			
	Description	Purchased before 09/06/16	Purchased after 09/06/16
Q	Pressure Hose (red) 17 ft.	782134S	782286S
R	Suction Hose (green) 12 ft.	782117S	782287S
S	Hose Asm, Pump to Reg	772040S	
T	Hose Asm, Reg to Filter	772039S	
U	Hose Asm, Pump to Filter	772038S	



Purchase service parts directly from the DAVCO on-line store. Scan this code with your cell phone to go directly to the Shop Pro ST Service Parts page.



SERVICE PARTS - ADAPTERS

ADAPTERS				
Description	Purchased before 09/06/16		Purchased after 09/06/16	
Compucheck Adapter (Blue)	782236S		782294S	
Pick-Up Wand (60" tube)	782114S		782289S	
Dispensing Wand (20" tube)	782133S		782288S	

NAVISTAR HOSE KITS				
Description	Purchased before 09/06/16		Purchased after 09/06/16	
Voss Fitting Adapter (Red)	782207S		782293S	
Angled Voss Adapter (Green)	782206S		782292S	
Includes Voss Fitting Adapter (Red) and Angled Voss Adapter (Green) for Navistar Engines	782320S	 	782319S	 

FITTINGS				
Description	Purchased before 09/06/16		Purchased after 09/06/16	
Quick Connect Fitting for Pressure/Suction hoses	103119S		782284S	
Compucheck Fitting for 782236S/782294S	782012S			



A Clarience Technologies Company

WARRANTY POLICY

Please review DAVCO's Product Warranty terms and conditions carefully before installing and/or using a DAVCO product.

Diesel Pro® 243, Diesel Pro® 245, Fuel Pro® 382, Fuel Pro® 482, Fuel Pro® 483, Fuel Pro® 485, Fuel Pro® 487, Industrial Pro®, Pro-Chek®, Sea Pro®

DAVCO Technology, LLC warrants these products to be free of defects in material and workmanship for five years, 500,000 miles or 10,000 hours (whichever comes first) and electrical parts for two-years, 200,000 miles or 4,000 hours (whichever comes first) from the purchase date*.

Shop Pro®

DAVCO Technology, LLC warrants the Shop Pro (except for the motor) to be free of defects in material and workmanship for two years from the date of purchase. The Shop Pro motor is warranted for one year from date of purchase.

REN Products, EyeMax®, and Fuel Pro® 384

DAVCO Technology, LLC warrants these products to be free of defects in material and workmanship for two-years or 200,000 miles (whichever comes first) from the purchase date.

By installing and/or using the product, you agree to be bound by the following:

This Warranty does not apply to:

- Failure or inadequate performance due to improper installation, misuse, misapplication, faulty installation, alteration/modification, poor maintenance, neglect, accident, or conditions resulting from actions outside DAVCO's control, including but not limited to the use of contaminated, corrosive, and unapproved fluids.
- Downtime, loss of use, loss of profits or income, loss of capital, cost of substitute equipment, living expenses, claims by purchaser's customers or other third parties, or other incidental, special or consequential damages.
- Attachments, accessory items, and parts not manufactured or distributed by DAVCO.
- Any aftermarket or OEM component not approved specifically to work with a DAVCO manufactured product
- Product that has been installed with aftermarket parts or altered or modified in any way.
- Normal wear and tear, abuse, vandalism, acts of God, improper storage or handling, disasters such as flood, fire, or war, failure to operate, maintain or repair in accordance with instructions, or failure to repair the vehicle into which the product is installed in accordance with the vehicle manufacturer's instructions or common maintenance practices.

This warranty is the sole warranty made by DAVCO. DAVCO makes no other warranties, expressed or implied, of merchantability or fitness for a particular purpose.

In the unlikely event of a defective product, DAVCO will either rework the defective product or replace it at DAVCO's discretion. If you feel you have a warrantable issue, contact DAVCO at 800-328-2611 for a Return Goods Authorization (RGA) number **. An RGA number is required prior to the return of any product.

* Purchase Date: The date of the first retail purchase of a new vehicle or piece of equipment from the OEM dealer or factory. For "Over the Counter" purchase: The date of sale to the first retail customer.

**Products submitted for Warranty consideration will be inspected by DAVCO personnel. Re-work or replacement will be based on DAVCO's Warranty procedure and/or the results of their evaluation. DAVCO's Warranty Program does not in any way constitute a product guarantee.



A Clarience Technologies Company

PARTS RETURN POLICY

Parts Return General Policy

A Return Goods Authorization (RGA) must be obtained from DAVCO prior to returning any products. Returns may be accepted under the following circumstances:

- **Order Shipping Error:** A credit against the original invoice, including freight charges for both ways will be issued for returns in which DAVCO inadvertently shipped incorrect quantity or product.
- **Overstock:** Returns for ordering more product(s) than required, or incorrect part(s), will be accepted within 60 days from the date of purchase. Proof of purchase will be required, i.e.: original invoice/delivery receipt. These types of return(s) are subject to a minimum restock fee of 40% or \$40.00, whichever is higher. Additional restock fees may apply. Product(s) will be inspected for "like new" condition and additional costs will be the responsibility of the customer. No obsolete parts may be returned.
- **Freight charges for return(s) will be the responsibility of the customer.**

